

YAMAYO®

(Classic

**1) Calipers
Vernier Calipers**

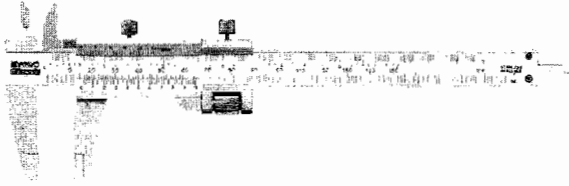

SPECIFICATION		
METRIC / INCH		
RANGE		PRICE
6"	150 mm	750/-
8"	200 mm	950/-
12"	300 mm	1850/-
18"	450 mm	7000/-
24"	600 mm	7800/-

2) Heavy Duty Type Vernier Calipers



SPECIFICATION		
METRIC / INCH		
RANGE		PRICE
18"	450 mm	2500/-
24"	600 mm	2800/-
40"	1,000 mm	7500/-
60"	1,500 mm	20000/-
80"	2,000 mm	35000/-

3) Heavy Duty Solid Type Vernier Calipers



SPECIFICATION		
METRIC / INCH		
RANGE		PRICE
18"	450 mm	3300/-
24"	600 mm	4200/-
40"	1000 mm	9500/-
60"	1,500 mm	22000/-
80"	2,000 mm	45000/-

4) Long Jaws Vernier Calipers

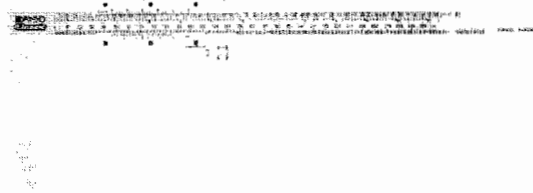

SPECIFICATION			
METRIC / INCH			
JAW LENGTH	RANGE		PRICE
100 mm	12"	300 mm	2800/-
200 mm	18"	450 mm	4800/-
200 mm	24"	600 mm	5800/-
200 mm	40"	1000 mm	12500/-

5)

**Calipers
Carbide Jaws Type Calipers**

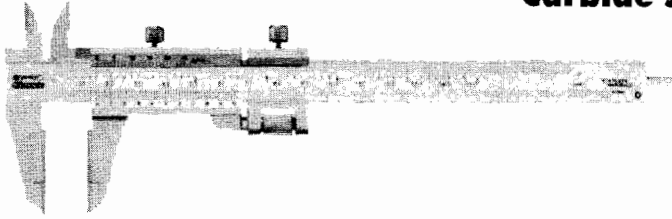

SPECIFICATION
METRIC / INCH

RANGE	PRICE
6" / 150 mm	3400/-
8" / 200 mm	4500/-
12" / 300 mm	6000/-

6) *Bliss*

**Calipers
Vernier Calipers**

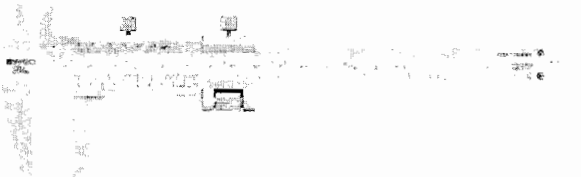

SPECIFICATION
METRIC / INCH

RANGE	PRICE
6" / 150 mm	1050/-
8" / 200 mm	1300/-
12" / 300 mm	2200/-
0-150 mm	1050/-
0-200 mm	1300/-
0-300 mm	2200/-

7) *Bliss*

**Calipers
Vernier Calipers**



SPECIFICATION
METRIC / INCH

RANGE	PRICE
18" / 450 mm	4500/-
24" / 600 mm	5800/-
40" / 1000 mm	14500/-

8) *Bliss*

**Vernier Calipers
without Fine Adjustment**

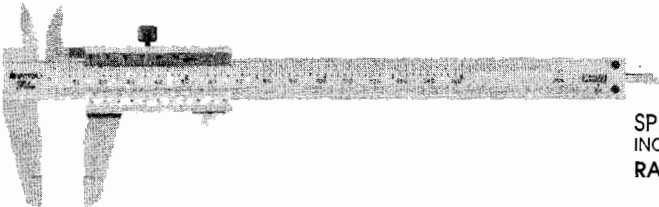

SPECIFICATION
INCH

RANGE	PRICE
6"	950/-
8"	1200/-
12"	2100/-

9)

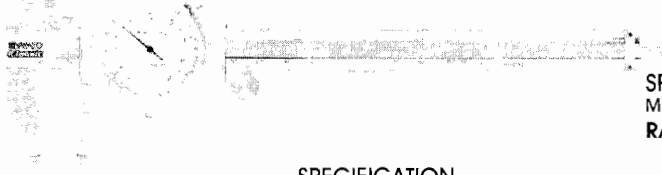

(Classic Dial Calipers

SPECIFICATION METRIC (0.02MM)	
RANGE	PRICE
0-150 mm	1200/-
0-200 mm	1800/-
0-300 mm	2800/-

SPECIFICATION METRIC (0.01MM)	
RANGE	PRICE
0-150 mm	1500/-

INCH	
RANGE	PRICE
0-6"	1200/-
0-8"	1800/-
0-12"	2800/-

10)

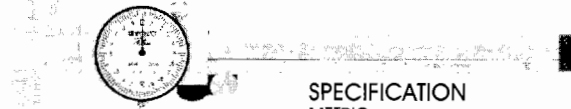

Dial Calipers

Bliss

SPECIFICATION METRIC	
RANGE	PRICE
0-150 mm	1450/-
0-200 mm	2150/-
0-300 mm	3300/-
0-450 mm	7000/-
0-600 mm	9800/-

INCH	
RANGE	PRICE
0-6"	1450/-
0-8"	2150/-
0-12"	3300/-

11)

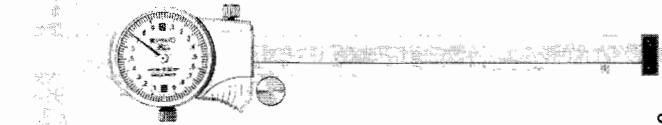

Gold Dial Calipers

Bliss

SPECIFICATION METRIC / INCH	
RANGE	PRICE
150 mm	2100/-
200 mm	2850/-

12)

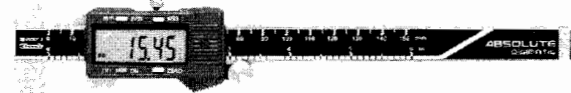

(Classic Digimatic Calipers

SPECIFICATION METRIC / INCH	
RANGE	PRICE
6" / 150 mm	1200/-
8" / 200 mm	1750/-
12" / 300 mm	3000/-
24" / 600 mm	8500/-
40" / 1,000 mm	20000/-

13) *Bliss*

Digimatic Calipers

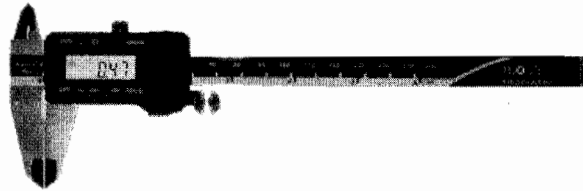

SPECIFICATION
METRIC / INCH

RANGE	PRICE
6" / 150 mm	1800/-
8" / 200 mm	2700/-
12" / 300 mm	4800/-

14)

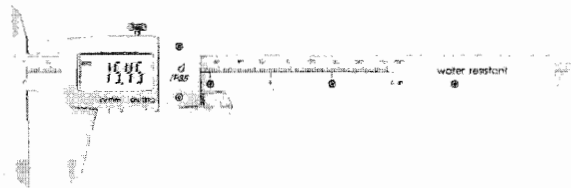

Water Proof Calipers

SPECIFICATION
METRIC / INCH

RANGE	PRICE
6" / 150 mm	4500/-

15)

Digimatic Carbide Jaw Vernier

SPECIFICATION
METRIC / INCH

RANGE	CLASSIC
6" / 150 mm	4500/-

16)

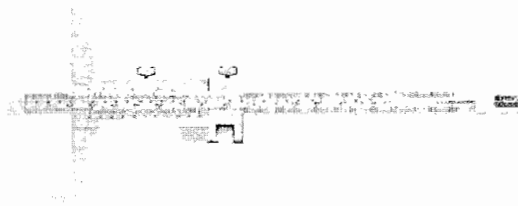

Classic Calipers Vernier Depth Calipers

SPECIFICATION
METRIC / INCH

RANGE	CLASSIC
6" / 150 mm	700/-
8" / 200 mm	850/-
12" / 300 mm	1000/-
24" / 600 mm	2400/-
40" / 1000 mm	7000/-

17)

Bliss

Digimatic Depth Vernier

SPECIFICATION
METRIC / INCH

RANGE	CLASSIC
6" / 150 mm	2400/-
8" / 200 mm	2850/-

18)

Gear Tooth Vernier Calipers

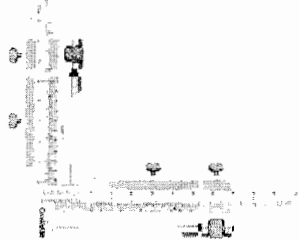

SPECIFICATION

METRIC

RANGE

Modul 1-26 mm

PRICE

2800/-

19)

Gear Tooth Vernier Calipers

Bliss

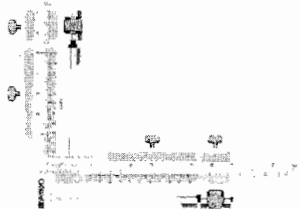

SPECIFICATION

METRIC

RANGE

Modul 1-26 mm

PRICE

3600/-

20)

Vernier Height Calipers



SPECIFICATION

METRIC / INCH

RANGE

12" / 300 mm

18" / 450 mm

24" / 600 mm

40"/1000mm

PRICE

2850/-

4800/-

5400/-

18500/-

21)

Vernier Height Calipers

Bliss



SPECIFICATION

METRIC / INCH

RANGE

12" / 300 mm

18" / 450 mm

24" / 600 mm

40"/1000mm

PRICE

6500/-

8300/-

9200/-

28000/-

22) P Type Dial Caliper Gauge

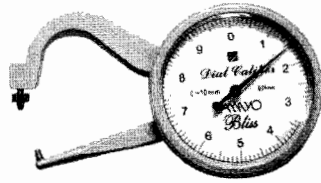

SPECIFICATION	
METRIC / INCH	
RANGE	PRICE
0 - 10 mm (0.05 mm)	1600/-
0 - 10 mm (Long Arm 70 mm)	2300/-
BEZEL ARM	1650/-

23) Digital Type Dial Height Calipers



SPECIFICATION	
METRIC	
RANGE	PRICE
0-300 mm	7000/-
0-600 mm	17000/-
{3 Column} 0-1000 mm	70000/-

24) Digital Type Dial Height Calipers

Bliss



SPECIFICATION	
METRIC	
RANGE	PRICE
0-300 mm	9000/-
0-600 mm	18500/-

25)

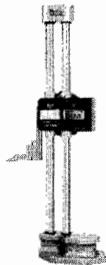

**Calipers
Digimatic Height Calipers**

SPECIFICATION	
METRIC / INCH	
RANGE	PRICE
12" / 300 mm	15000/-
24" / 600 mm	25000/-

26)



**Calipers
Digimatic Height Calipers** *Bliss*

SPECIFICATION	
METRIC / INCH	
RANGE	PRICE
12" / 300 mm	20000/-

27)

Micrometer Head

SPECIFICATION
METRIC

RANGE

0-25 mm (0.01 mm)

PRICE

450/-

28)

**Micrometer
Outside Micrometers**

SPECIFICATION
METRIC

RANGE

0-25 mm

25-50 mm

50-75 mm

75-100 mm

100-125 mm

125-150 mm

PRICE

600/-

700/-

780/-

900/-

1100/-

1150/-

INCH

RANGE

0-1"

1"-2"

2"-3"

3"-4"

PRICE

600/-

700/-

780/-

900/-

29)

**(Classic
Micrometer
Outside Micrometers**

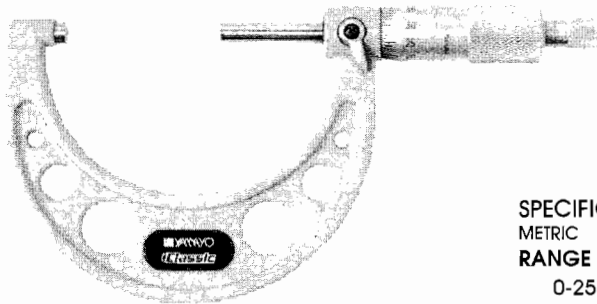

SPECIFICATION
METRIC

RANGE

0-25 mm

25-50 mm

50-75 mm

75-100 mm

100-125 mm

125-150 mm

150-175 mm

175-200 mm

200-225 mm

225-250 mm

250-275 mm

275-300 mm

PRICE

625/-

750/-

800/-

950/-

1100/-

1200/-

1400/-

1600/-

2000/-

2200/-

2400/-

2600/-

INCH

RANGE

0-1"

1-2"

2-3"

3-4"

4-5"

5-6"

6-7"

7-8"

PRICE

625/-

750/-

800/-

950/-

1100/-

1200/-

1400/-

1600/-

SPECIFICATION
METRIC (0.001")

RANGE

0-1"

1-2"

2-3"

3-4"

SPECIFICATION
METRIC (0.001)

RANGE

0-25 mm

25-50 mm

50-75 mm

75-100 mm

PRICE

900/-

1000/-

1150/-

1250/-

30) Micrometer Large Outside Micrometers

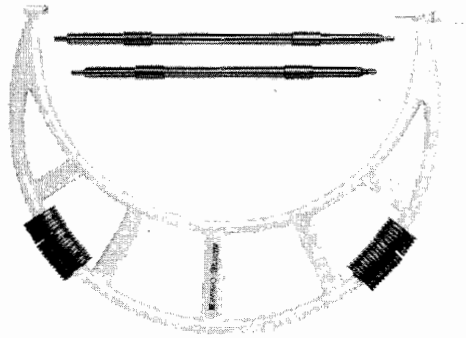

SPECIFICATION METRIC

RANGE	PRICE
300-400 mm	7000/-
400-500 mm	8000/-
500-600 mm	9500/-
600-700 mm	11000/-
700-800 mm	13000/-
800-900 mm	16500/-
900-1,000 mm	18000/-
1,000-1,200 mm	42000/-
1,200-1,400 mm	55000/-
1,400-1,600 mm	65000/-

31) Adjustable Micrometers Tubular Type

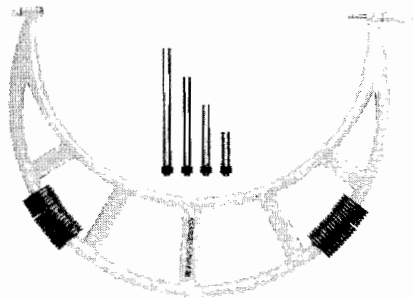

SPECIFICATION METRIC

RANGE	PRICE
300-400 mm	8500/-
400-500 mm	9500/-
500-600 mm	1100/-
600-700 mm	13500/-
700-800 mm	16000/-
800-900 mm	18000/-
900-1,000 mm	21000/-

32) Adjustable Outside Micrometers

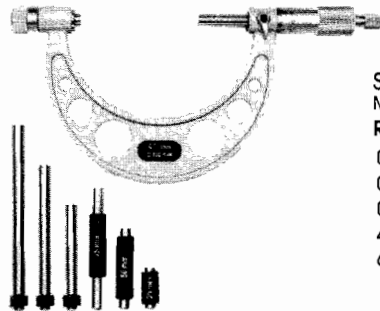

SPECIFICATION METRIC

RANGE	PRICE
0-2"	2000/-
0-4"	3850/-
0-6"	4500/-
4"-8"	5800/-
6"-12"	6500/-

SPECIFICATION METRIC

RANGE	PRICE
0-50 mm	2000/-
0-100 mm	3850/-
0-150 mm	4500/-
50-150 mm	4200/-
100-200 mm	5800/-
150-300 mm	6500/-
200-300 mm	6500/-

33)

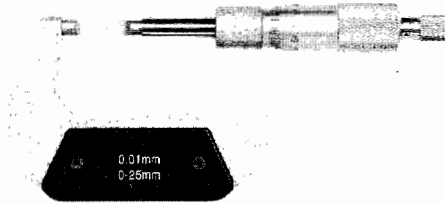

Blade Outside Micrometers

SPECIFICATION METRIC		
RANGE	PRICE	
(6.5 x 0.75) 0-25 mm	3800/-	
25-50 mm	4200/-	
50-75 mm	4500/-	
75-100 mm	5000/-	
BLADE	RANGE	PRICE
6.5 x 0.40	0-25mm	6000/-

34)

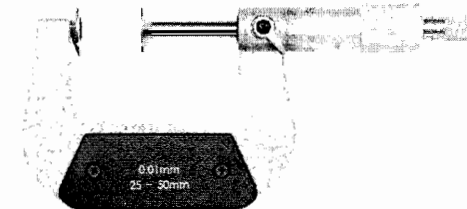

Disc Micrometers

SPECIFICATION METRIC		
RANGE	PRICE	
0-25 mm	2000/-	
25-50 mm	2300/-	
50-75 mm	2600/-	
75-100 mm	3000/-	
100-125 mm	3500/-	
125-150 mm	4000/-	
150-175 mm	4300/-	
175-200 mm	4800/-	
200-225 mm	8000/-	
225-250 mm	8800/-	
250-275 mm	9800/-	
275-300 mm	11000/-	

35)

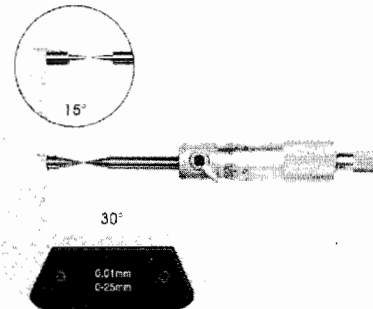

Point Micrometers

SPECIFICATION METRIC		
RANGE	PRICE	
15° 0-25 mm	3000/-	
30° 0-25 mm	3000/-	

36)

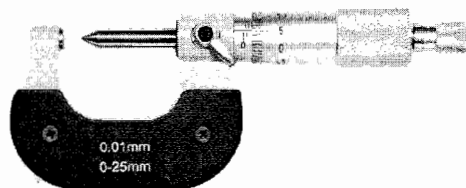

Crimp Height Micrometers

SPECIFICATION METRIC		
RANGE	PRICE	
0-25 mm	3800/-	

37) Digimatic Crimp Height Micrometers

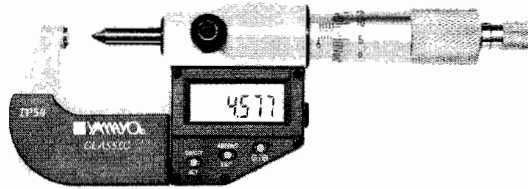

SPECIFICATION
METRIC / INCH
RANGE
0-25 mm / 0.01"

PRICE
9500/-

**38) Calipers/Micrometer
Digit Micrometers**

Bliss

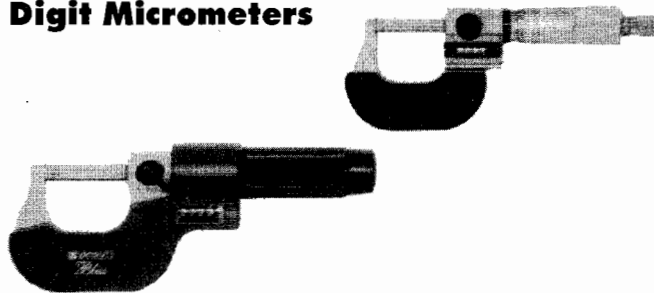

SPECIFICATION
METRIC
RANGE
0-25 (0.01 mm)
0-25 (0.001 mm)

PRICE
1400/-
1800/-

39) Digimatic Outside Micrometers

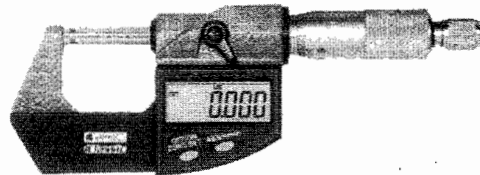

SPECIFICATION
METRIC / INCH
RANGE

PRICE

0-25 mm / 0-1"	3300/-
25-50 mm / 1-2"	3850/-
50-75 mm / 2-3"	4500/-
75-100 mm / 3-4"	5000/-

**40) Micrometer/Miscellaneous
Screw Thread Micrometers**

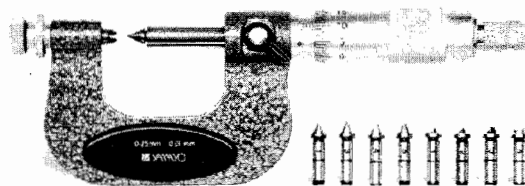

SPECIFICATION
METRIC / INCH
RANGE

PRICE

0-25 mm	3000/-
25-50 mm	3300/-

41)

Tube Micrometer

	SPECIFICATION	
	METRIC	
	RANGE	PRICE
Double Ball	0-25 mm	1050/-
Single Ball	0-25 mm	950/-

42)

**Micrometer
Groove Micrometers**



	SPECIFICATION	
	METRIC	
	RANGE	PRICE
Small (6.5mm)	0-25 mm	7500/-
Large (13mm)	0-25 mm	8000/-

43)

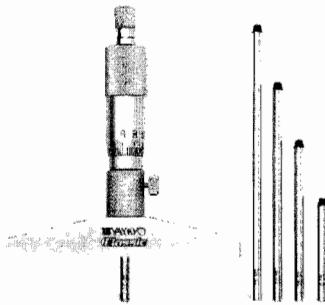

**Micrometer
Depth Micrometers**

	SPECIFICATION	
	METRIC	
	RANGE	PRICE
	0-25 mm	2000/-
	0-50 mm	2400/-
	0-100 mm	3400/-
	0-150 mm	4000/-

44)

Jaw Type Inside Micrometers

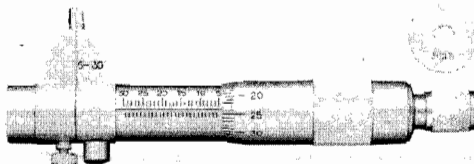

	SPECIFICATION	
	METRIC	
	RANGE	PRICE
	5-30 mm	2000/-
	25-50 mm	2200/-

45) Tubular Inside Micrometers

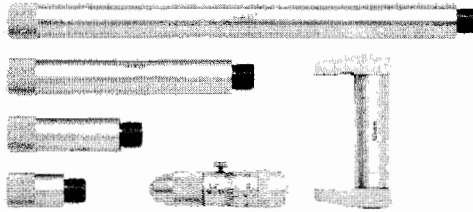

SPECIFICATION METRIC

RANGE	PRICE
50-300 mm	3800/-
50-500 mm	4600/-
50-1000 mm	11500/-
50-1500 mm	15000/-
100-2100 mm	23000/-

46) Inside Micrometers Rod Type

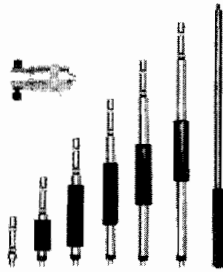

SPECIFICATION METRIC

RANGE	PRICE
25-50 mm	3200/-
50-200 mm	4200/-
50-300 mm	4800/-

47) Indicators Dial Caliper Gauges

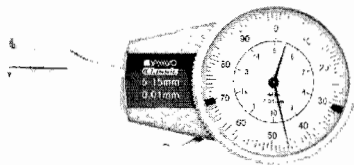

SPECIFICATION METRIC

RANGE	PRICE
5-25 mm	6800/-
10-30 mm	7500/-
30-50 mm	8000/-
40-60 mm	8500/-

48) Inside Pistol Calipers

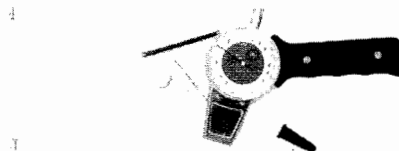

SPECIFICATION METRIC

RANGE	PRICE
15-35mm	4300/-
35-55mm	4500/-
55-75 mm	4700/-
75-95 mm	4800/-
95-115 mm	5100/-
115-135 mm	5500/-

49)

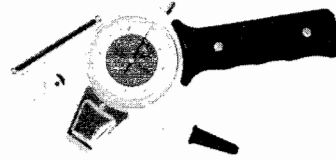

SPECIFICATION
METRIC / INCH

RANGE	PRICE
0-20 mm	4500/-

50)

Bore Gauges



SPECIFICATION
METRIC

RANGE	PRICE
6-10 mm	3800/-
10-18 mm	3400/-
18-35 mm	2700/-
35-60 mm	2700/-
50-150 mm	2850/-
160-250 mm	3500/-
250-450 mm	3800/-

51)

Bore Gauges

Bliss

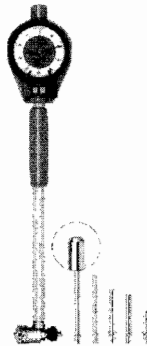

SPECIFICATION
METRIC

RANGE	PRICE
10-18 mm	5200/-
18-35 mm	4000/-
35-60 mm	4000/-
50-150 mm	4200/-
160-250 mm	4300/-
250-450 mm	5000/-

52)

Dial Indicators

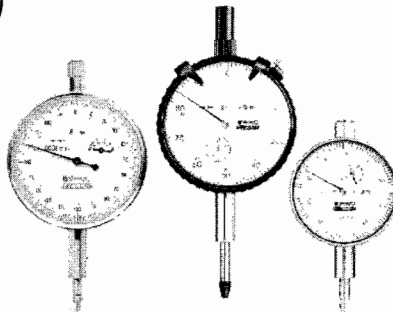

SPECIFICATION
METRIC

RANGE	PRICE
(0.01) 0-5 mm	850/-
(0.01) 0-10 mm	650/-
(0.001) 0-10 mm	1600/-

53) Digimatic Indicators



SPECIFICATION
METRIC

RANGE	PRICE
0.010-12.7 mm	3000/-
0.001-12.7 mm	4500/-

54) Indicators Dial Test Indicators

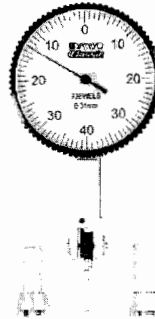

SPECIFICATION
METRIC / INCH

RANGE	PRICE
0-0.8 mm	1700/-

55) Digimatic Test Indicators

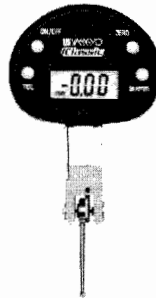

SPECIFICATION
METRIC / INCH

RANGE	PRICE
0-0.8 mm	6500/-

56) Multi Function Indicators

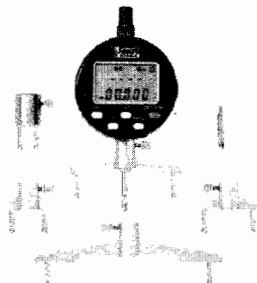

SPECIFICATION
METRIC / INCH

MEASURING RANGE	PRICE
Radius 5-10000mm/Linear 0-13mm	11500/-

57) *Bliss*

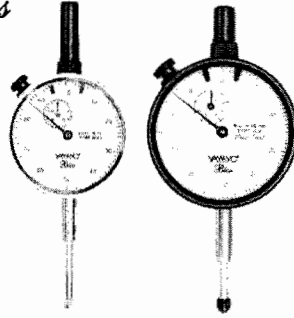

Dial Indicators
Dial indicators

SPECIFICATION
METRIC

RANGE (0.01 mm)	PRICE
0-10 mm	850/-
0-25 mm	1550/-

DOUBLE FACE DIAL

RANGE	PRICE
0.01-10 mm	4500/-

58)

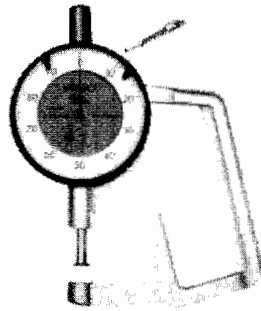

Dial Thickness Gauge

SPECIFICATION

RANGE	PRICE
0-10mm (0.01mm)	2500/-

59) *Bliss*

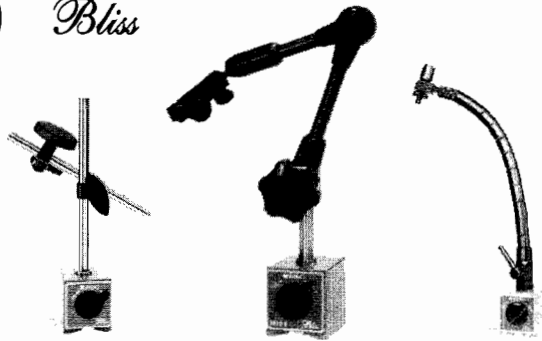

Dial Indicators
Magnetic Stands

SPECIFICATION

CODE	PRICE
7010 S	800/-
7011 S	850/-
7012 S	1500/-
7019 B	7000/-
7027 B	8500/-

60)

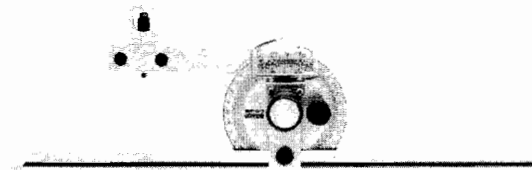

Miscellaneous
Bevel Protractor

SPECIFICATION
METRIC

BLADE LENGTH	PRICE
300 mm / 12"	2300/-

61) Bevel Protractor

Bliss

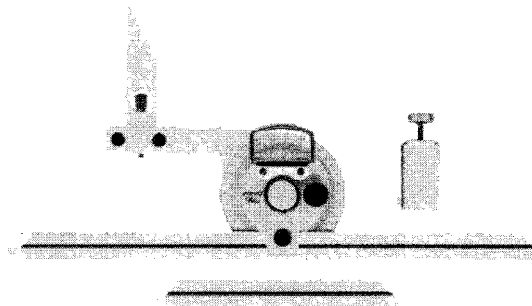

SPECIFICATION
METRIC

BLADE LENGTH	PRICE
300 mm / 12"	3500/-

62) Gauge Block Set

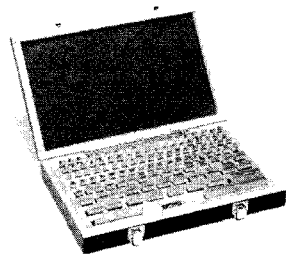

SPECIFICATION
METRIC

BLOCK PER SET	PRICE
112	12500/-
87	9000/-
83	8000/-

63) Micrometers/Miscellaneous Small Hole Gauges

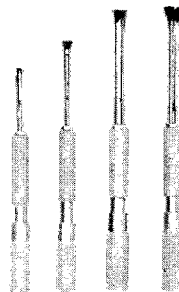

SPECIFICATION
METRIC

RANGE	PRICE
3-13 mm	650/-

64) Telescoping Gauges

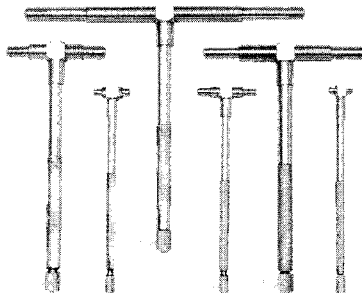

SPECIFICATION
METRIC / INCH

RANGE	PRICE
8-150 mm	700/-

65)

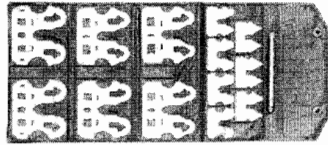

Miscellaneous Radius Gauge

SPECIFICATION
METRIC

RANGE	PRICE
0.5-13 mm	1700/-

SPECIFICATION
METRIC

RANGE	PRICE
15.5-25 mm	265/-

66)

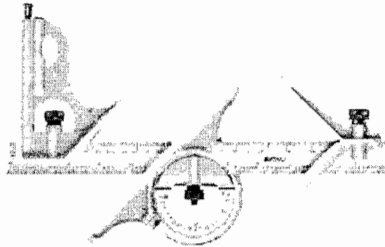

Combination Square Set

SPECIFICATION
METRIC / INCH

RANGE	PRICE
300 mm / 12"	2300/-
600 mm / 24"	4100/-

SCALE FOR COMBINATION SET
METRIC / INCH

RANGE	PRICE
300 mm / 12"	800/-
600 mm / 24"	1800/-

67)

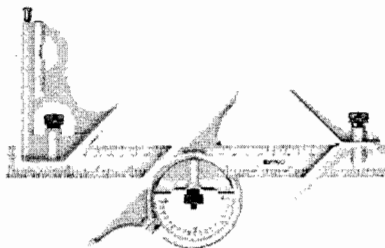

Combination Square Set

Bliss

SPECIFICATION
METRIC / INCH

RANGE	PRICE
300 mm / 12"	3500/-

68)



Straight Edge

SPECIFICATION
METRIC / INCH

SIZE (L X W X H)	PRICE
1000 x 10 x 50 mm	3200/-
1500 x 12 x 60 mm	8500/-
2000 x 12 x 60 mm	12000/-

69)

Block Level

SPECIFICATION

SIZE	PRICE
150 mm / 6" (0.02mm)	4500/-

70)

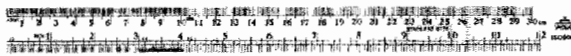

Steel Rulers

SPECIFICATION
MATT FINISH

SIZE	PRICE
150 mm / 6	12/-
300 mm / 12	30/-
300 mm / 24	100/-
1000 mm / 40	220/-
1200 mm / 48	350/-
2000 mm / 80	1600/-

71) Spirit Levels

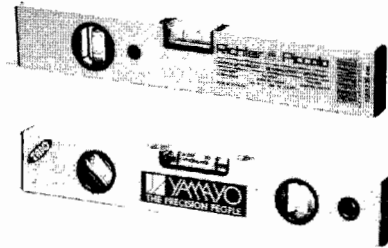

SPECIFICATION

ORDER NAME	SIZE	PRICE
Trio	200 mm	120/-
Trio	300 mm	150/-
Trio	450 mm	210/-
Trio	600 mm	265/-
Trio	1000 mm	500/-
Trio	1200 mm	800/-
Trio	1500 mm	1000/-
Trio	2000 mm	1200/-
Piccolo	300 mm	230/-
Piccolo	450 mm	300/-
Piccolo	600 mm	350/-
Millenium	900 mm	300/-
Millenium	1200 mm	400/-

72)

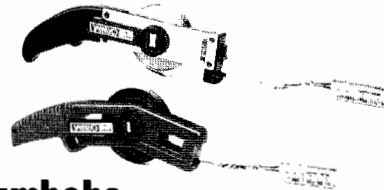

Measuring Tapes Oil Tapes

SPECIFICATION
METRIC

SIZE	WIDTH	PRICE	
		4" BOB	6" BOB
M.S. 10 mts	12.5 mm	625/-	750/-
S.S. 10 mts	12.5 mm	1150/-	1250/-
M.S. 15 mts	12.5 mm	650/-	775/-
S.S. 15 mts	12.5 mm	1300/-	1450/-
M.S. 20 mts	12.5 mm	750/-	850/-
S.S. 20 mts	12.5 mm	1500/-	1600/-
M.S. 30 mts	12.5 mm	900/-	1025/-
S.S. 30 mts	12.5 mm	1850/-	2000/-
M.S. 50 mts	12.5 mm	1500/-	1600/-
S.S. 50 mts	12.5 mm	4800/-	5200/-
M.S. 100 mts	12.5 mm	3000/-	3200/-
S.S. 100 mts	12.5 mm	8500/-	9000/-

Plumbobs

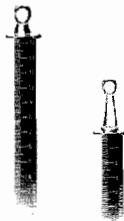

* Note :
200/- extra for Alluminium Handle
200/- extra for "SS" Bob

Oil Tape Refills

SPECIFICATION
METRIC

SIZE	WIDTH	PRICE
M.S. 10 mts	12.5 mm	220/-
S.S. 10 mts	12.5 mm	675/-
M.S. 15 mts	12.5 mm	250/-
S.S. 15 mts	12.5 mm	825/-
M.S. 20 mts	12.5 mm	340/-
S.S. 20 mts	12.5 mm	1050/-
M.S. 30 mts	12.5 mm	525/-
S.S. 30 mts	12.5 mm	1450/-
M.S. 50 mts	12.5 mm	1000/-
S.S. 50 mts	12.5 mm	4300/-
M.S. 100 mts	12.5 mm	2600/-
S.S. 100 mts	12.5 mm	8000/-

73)

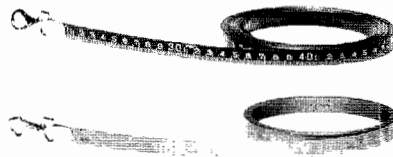

NEW BRIGHT FINISH IN S.S. REFIL

10 mts	15 mts	20 mts	30 mts	50 mts	100 mts
750/-	910/-	1155/-	1600/-	4750/-	8800/-